

REVISION HISTORY			
REV	DESCRIPTION	DATE	APPROVED

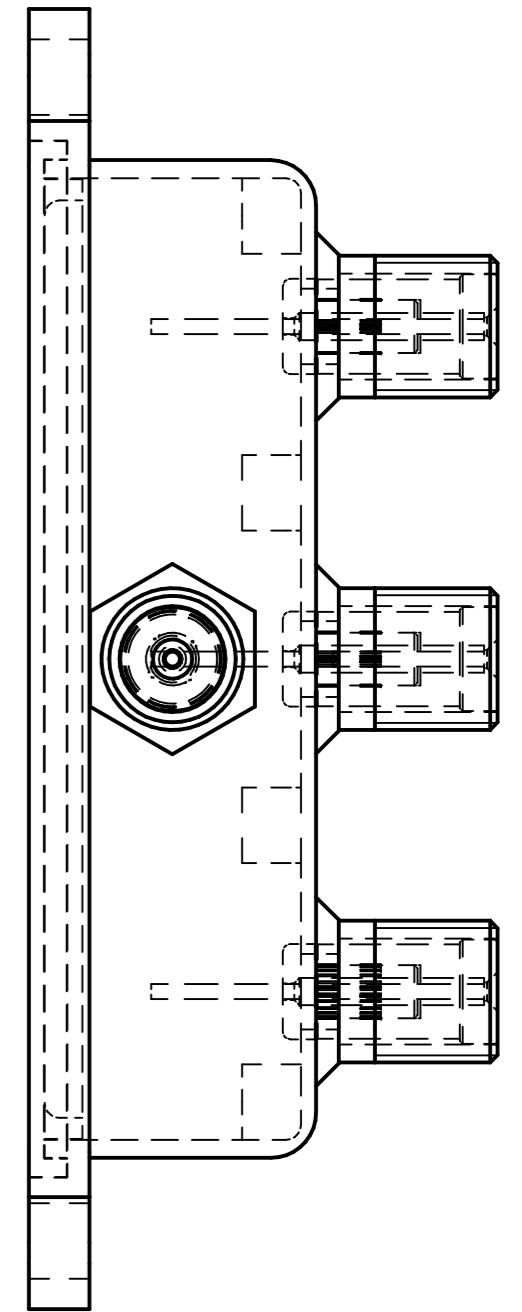
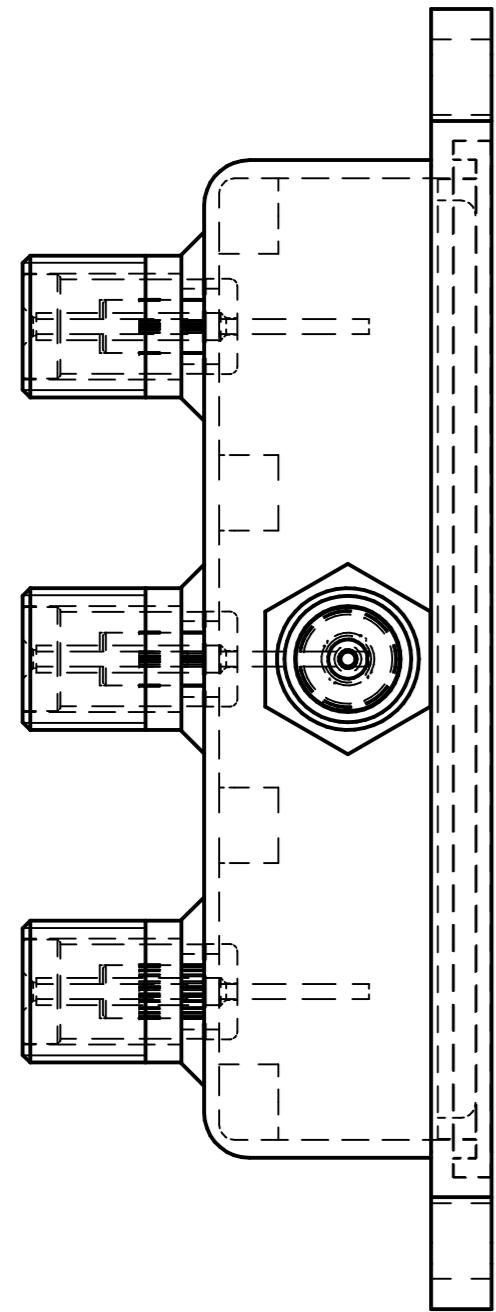
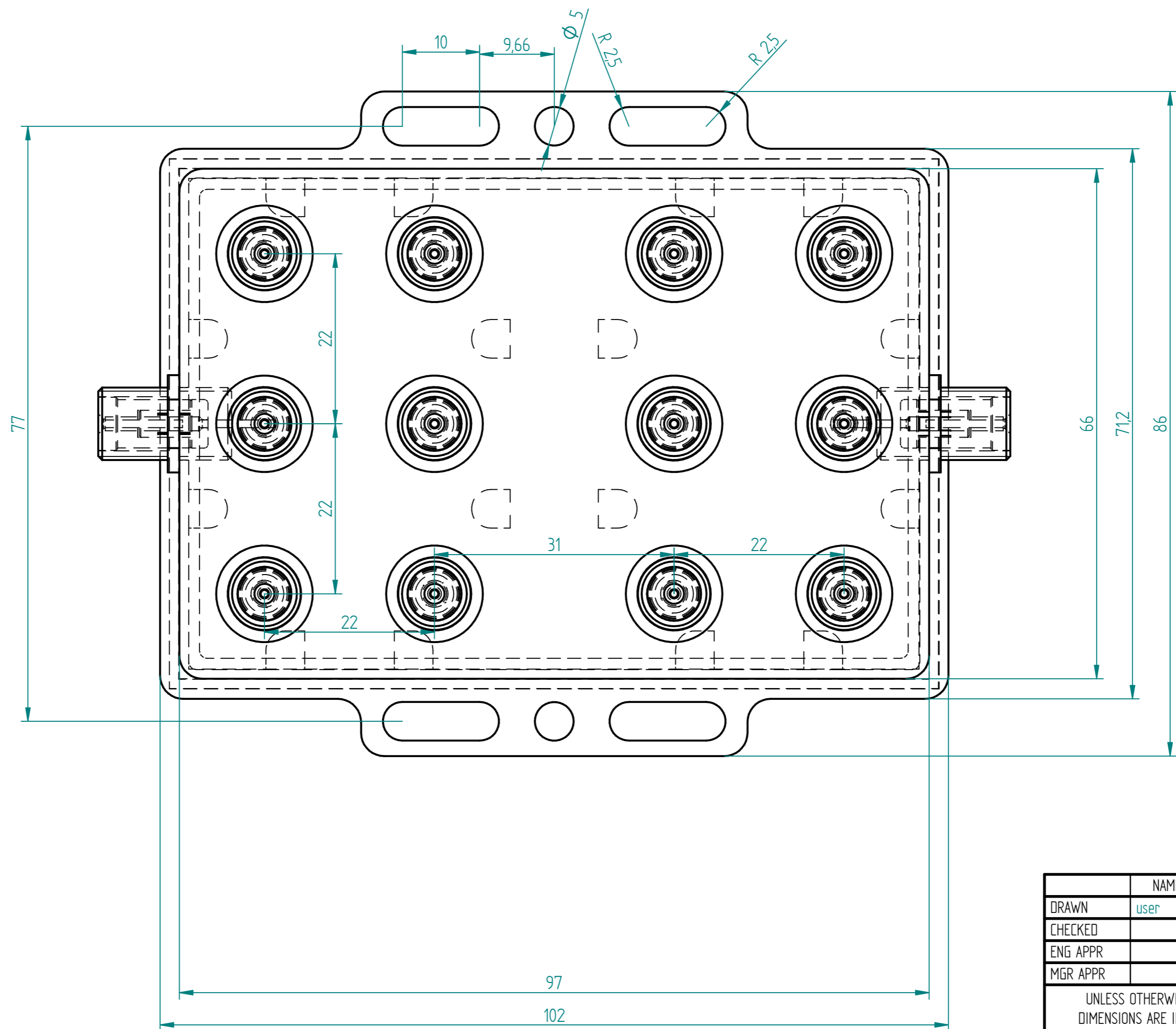
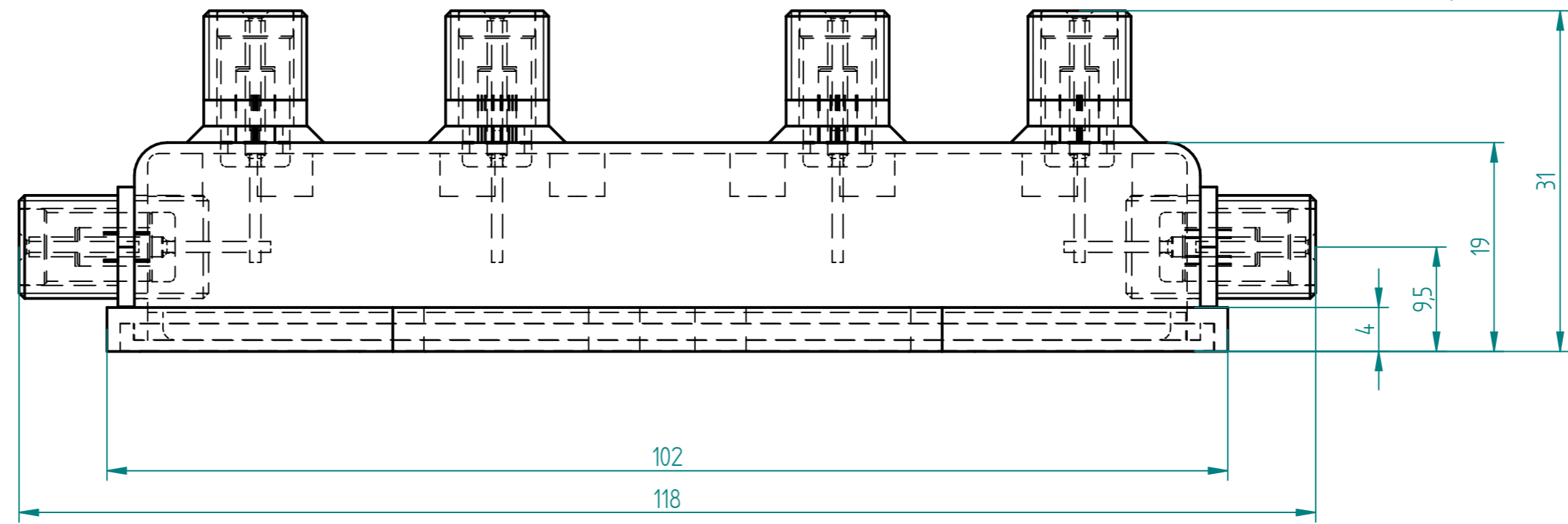
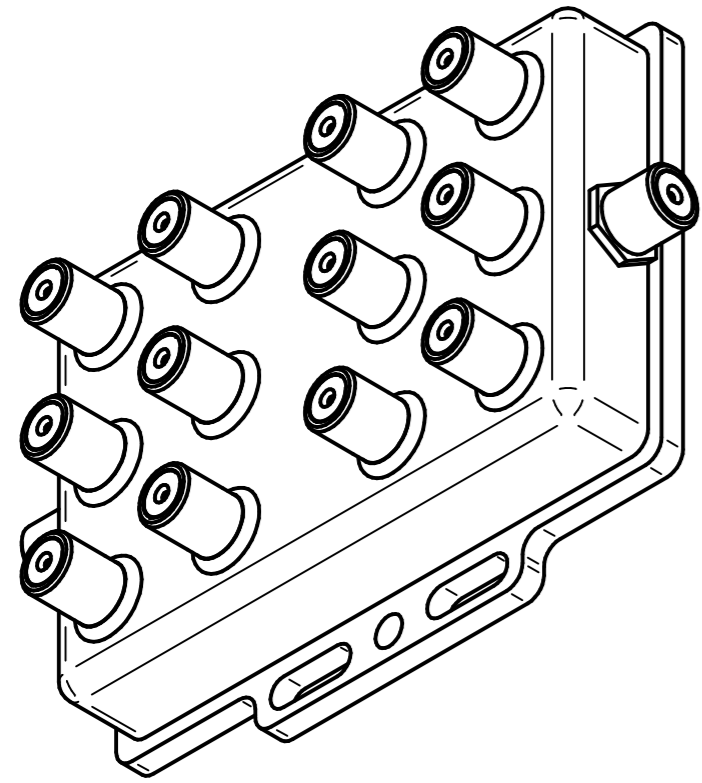

	NAME	DATE	Solid Edge		
DRAWN	user	11/13/14			
CHECKED					
ENG APPR					
MGR APPR			TITLE		
UNLESS OTHERWISE SPECIFIED DIMENSIONS ARE IN MILLIMETERS ANGLES ±X.X° 2 PL ±XXX 3 PL ±XXXX			SIZE	DWG NO	REV
			A2		
SCALE:			WEIGHT:	SHEET 1 OF 1	